



# BradyPrinter i5100

INDUSTRIAL LABEL PRINTER

PRINTER SETTINGS  
CONFIGURATIONS AND  
CONNECTIVITY MANUAL

## Table of Contents

<b>1</b>	<b>Introduction .....</b>	<b>5</b>
<b>2</b>	<b>Connecting Label Printer to Computer .....</b>	<b>6</b>
2.1	Print Services Raw-IP and LPR/LPD in MS Windows .....	6
2.2	Adjusting Windows Printer Setting .....	6
2.3	Connecting Label Printer via Ethernet Interface .....	7
2.4	Setting Up a Wi-Fi Connection .....	7
2.4.1	Connecting Printer to Network .....	7
2.4.2	Installing a Hotspot .....	8
2.5	Connecting Label Printer via USB Interface .....	8
2.6	Driver Installation .....	9
2.7	Connecting Label Printer via RS-232 interface .....	11
2.8	Setting Up a Bluetooth Connection .....	11
<b>3</b>	<b>Menu .....</b>	<b>12</b>
3.1	Structure of the Menu .....	12
3.2	Navigating in the Menu .....	13
3.3	Service Key .....	14
<b>4</b>	<b>Info.....</b>	<b>15</b>
<b>5</b>	<b>Security .....</b>	<b>16</b>
<b>6</b>	<b>Configuration.....</b>	<b>17</b>
6.1	Configuration via Control Panel .....	17
6.1.1	Printing .....	17
6.1.2	Labels .....	19
6.1.3	Ribbon .....	19
6.1.4	Tearing-off.....	20
6.1.5	Cutting .....	20
6.1.6	Peeling-off .....	20
6.1.7	Interfaces.....	21
6.1.8	Errors.....	24
6.1.9	Region .....	24
6.1.10	Time.....	25
6.1.11	Display .....	26
6.1.12	Interpreter .....	26
6.1.13	ZPL.....	26
6.2	Configuration via the Web Interface.....	27
6.2.1	Status Tab.....	28
6.2.2	Setup Tab .....	29
6.2.3	Security Tab.....	30
6.2.4	Devices Tab.....	31
6.2.5	Fonts Tab.....	32
6.2.6	Help Menu .....	33
<b>7</b>	<b>Test Functions .....</b>	<b>34</b>
7.1	Overview .....	34
7.2	Status Print.....	34
7.3	Font list.....	35
7.4	Device List.....	36
7.5	Test Grid.....	37
7.6	Wi-Fi Status.....	38
7.7	Demo Label.....	39

<b>8</b>	<b>Diagnostic Functions</b> .....	<b>40</b>
8.1	Printhead.....	40
8.2	ASCII Dump Mode.....	41
8.3	Label Profile.....	42
8.4	Event Log.....	43
8.5	Save Data Stream.....	44
8.6	Save Print Image.....	45
8.7	Save System Log.....	46
<b>9</b>	<b>Extras</b> .....	<b>47</b>
9.1	Firmware Update.....	47
9.2	Calibrate Label Sensor.....	47
9.3	Save Settings.....	47
9.4	Load Settings.....	48
9.5	Reset Settings.....	48
9.6	Reset Passwords.....	48
9.7	Cleaning Interval.....	49
9.8	Legal Notices.....	49
<b>10</b>	<b>Service Functions</b> .....	<b>50</b>
10.1	Reset Service Counter.....	50
10.2	Printhead Zero Position X.....	50
10.3	Printhead Zero Position Y.....	50
10.4	Printer Model.....	51
<b>11</b>	<b>FTP Printer Management</b> .....	<b>52</b>
11.1	FTP Login.....	52
11.2	FTP Printing.....	52
11.3	FTP Access to Storage Devices.....	52
11.4	FTP Firmware Update.....	53
<b>12</b>	<b>Storage Devices</b> .....	<b>54</b>
12.1	Suitable Storage Devices.....	54
12.2	Installation.....	54
12.3	Directory Structure.....	54
12.4	Writing.....	55
12.5	Storage Device Functions.....	55
12.5.1	Load Label.....	55
12.5.2	Print File List.....	56
12.5.3	Copy Files.....	56
12.5.4	Format Storage.....	56
12.5.5	Default Storage.....	57
<b>13</b>	<b>Remote Access via VNC</b> .....	<b>58</b>
<b>14</b>	<b>External Keyboard</b> .....	<b>59</b>
14.1	Connecting External Keyboard.....	59
14.2	Keyboard Assignment.....	59
14.3	Special Key Functions.....	60
<b>15</b>	<b>Index</b> .....	<b>61</b>

## Configuration Manual for the following products

Model	Configurations
i5100	i5100 Standard (300 & 600 dpi)
	i5100 AutoCut (300 & 600 dpi)

# BradyPrinter i5100

INDUSTRIAL LABEL PRINTER

### Disclaimer

This manual is proprietary to Brady Worldwide, Inc. (hereafter "Brady"), and may be revised from time to time without notice. Brady disclaims any understanding to provide you with such revisions, if any. This manual is copyrighted with all rights reserved. No portion of this manual may be copied or reproduced by any means without the prior written consent of Brady.

While every precaution has been taken in the preparation of this document, Brady assumes no liability to any party for any loss or damage caused by errors or omissions or by statements resulting from negligence, accident, or any other cause. Brady further assumes no liability arising out of the application or use of any product or system described, herein; nor any liability for incidental or consequential damages arising from the use of this document. Brady disclaims all warranties of merchantability of fitness for a particular purpose.

Brady reserves the right to make changes without further notice to any product or system described herein to improve reliability, function, or design.

### Trademark

Windows, Microsoft and Internet Explorer are registered trademarks of the Microsoft Corporation.

Bluetooth is a registered trademark of Bluetooth SIG, Inc.

Firefox is a registered trademark of Mozilla Foundation.

ZPL and Zebra logo are registered trademarks of ZIH Corporation.

BradyPrinter™ is a trademark of Brady Worldwide, Inc. All brand or product names referenced in this manual are trademarks (™) or registered trademarks (®) of their respective companies or organizations. ©2018 Brady Corporation. All rights reserved.

### Editor

Regarding questions or comments please contact Brady Technical Support.

### Topicality

Due to the constant further development of products discrepancies between documentation and product can occur. Please check BradyID.com for the latest update.

### Terms and conditions

Deliveries and performances are effected under the General conditions of sale of BradyPrinter i5100.

### Brady Warranty

Our products are sold with the understanding that the buyer will test them in actual use and determine for him or herself their adaptability to his/her intended uses. Brady warrants to the buyer that its products are free from defects in material and workmanship, but limits its obligation under this warranty to replacement of the product shown to Brady's satisfaction to have been defective at the time Brady sold it. This warranty does not extend to any persons obtaining the product from the buyer.

THIS WARRANTY IS IN LIEU OF ANY OTHER WARRANTY, EXPRESS OR IMPLIED, INCLUDING, BUT NOT LIMITED TO, ANY IMPLIED WARRANTY OF MERCHANTABILITY OR FITNESS FOR A PARTICULAR PURPOSE, AND OF ANY OTHER OBLIGATIONS OR LIABILITY ON BRADY'S PART. UNDER NO CIRCUMSTANCES WILL BRADY BE LIABLE FOR ANY LOSS, DAMAGE, EXPENSE OR CONSEQUENTIAL DAMAGES OF ANY KIND ARISING IN CONNECTION WITH THE USE, OR INABILITY TO USE, BRADY'S PRODUCTS.

## 1 Introduction

Important information and instructions in this documentation are designated as follows:



### **Danger!**

Draws attention to an exceptionally great, imminent danger to your health or life due to hazardous voltages.



### **Danger!**

Draws attention to a danger with high risk which, if not avoided, may result in death or serious injury.



### **Warning!**

Draws attention to a danger with medium risk which, if not avoided, may result in death or serious injury.



### **Caution!**

Draws attention to a danger with low risk which, if not avoided, may result in minor or moderate injury.



### **Attention!**

Draws attention to potential risks of property damage or loss of quality.



### **Note!**

Advices to make work routine easier or on important steps to be carried out.



### **Environment!**

Gives you tips on protecting the environment.



Handling instruction



Reference to section, position, illustration number or document.



Option (accessories, peripheral equipment, special fittings).

*Time*

Information in the display.

## 2 Connecting Label Printer to Computer

Choose from the following options for connecting a computer to the label printer:

- Direct connection to the Ethernet interface (6) ▷ 2.3 on page 7.
- Connection via a computer network to the Ethernet interface (6) ▷ 2.3 on page 7.
- Wi-Fi connection ▷ 2.4 on page 7.
- Connection to the full-speed USB slave interface (5) ▷ 2.5 on page 8.
- Connection to the RS-232 interface ▷ 2.7 on page 11.
- Connection via optional Bluetooth adapter connected to an USB master interface (4/9) ▷ 2.8 on page 11.

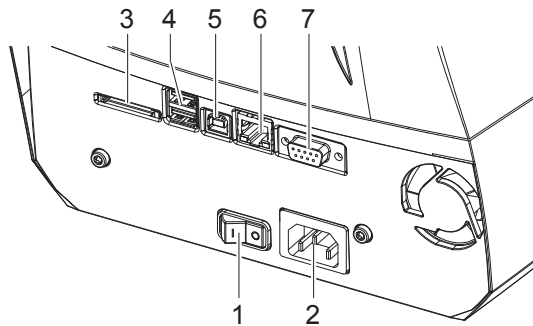

- 1 Power switch
- 2 Power connection jack
- 3 Slot for SD card
- 4 2 USB master ports for keyboard, scanner, USB memory stick, Bluetooth adapter or service key
- 5 USB full-speed slave port
- 6 Ethernet 10/100 Base-T
- 7 Serial RS-232 port

Figure 1 Connections

### 2.1 Print Services Raw-IP and LPR/LPD in MS Windows

- ▶ Install a standard TCP/IP port as additional port for printing.
- ▶ During installation of the new port choose between "Raw" and "LPR"
- ▶ Raw-IP: Enter the same port address in the printer which you have selected during installation.



**Notice!**

In the delivery status the print services RawIP (Port 9100) and LPD are activated on the printer ▷ page 23.

### 2.2 Adjusting Windows Printer Setting

When the printer driver valid for your Windows version is installed on your computer, Windows standard applications can be used to edit the label contents and to start the print jobs. To use the Raw-IP or LPR/LPD print services, the Windows printer settings must be adjusted:

1. Open the folder containing the printers via Start > Settings > Printers.
2. Right-click the icon of the label printer.  
A pop-up menu appears.
3. Select "Properties" in the pop-up menu.
4. Open the "Details" or "Connections" tab.  
This tab contains, among other things, the connections which were also set up when the print services were installed. The names of these connections depend on the installation tool used.
5. Select the Raw-IP or LPR connection.
6. Click **OK**.

## 2 Connecting Label Printer to Computer

### 2.3 Connecting Label Printer via Ethernet Interface

To connect the label printer to a network jack, a patch cable with an RJ45 plug for 10 Base T or 100 Base T is required.



#### Attention!

▶ **Use a shielded cable to connect the printer to the network.**

- ▶ Connect computer and label printer with a suitable cable.
- ▶ Make the settings for operation of the Ethernet interface ▷ 6.1.7 on page 21.
- ▶ Set up print service if necessary ▷ 2.1 on page 6.
- ▶ Adjust Windows printer setting ▷ 2.2 on page 6.



#### Attention!

▶ **Do not change the settings of the "IP" and "Gateway" on the printer web interface, as otherwise the connection to the printer may be lost.**

### 2.4 Setting Up a Wi-Fi Connection



#### 2.4.1 Connecting Printer to Network

\* Access only with service Wi-Fi stick installed.



#### Note!

**That mode allows to use an existing wireless network for controlling and configuring the printer and for sending print jobs to the printer.**

- ▶ Start menu.
- ▶ Select *Setup > Interfaces > Wi-Fi*.
- ▶ Activate *Wi-Fi* ▷ page 22.
- ▶ Select *Operation mode > Connect to network*.
- ▶ Select *Access-Point*.  
The search for access-points will be started.  
The display shows the available access-points including the hidden access-points.
- ▶ Select an access point and confirm with  .
- ▶ For hidden access-points enter the *SSID*.
- ▶ Setup *DHCP* or *IP* and *Mask* and if necessary *Gateway*.
- ▶ If the network is protected a prompt to enter the passkey appears in the printer display. Enter the passkey and select  .
- ▶ Set up print service if necessary ▷ 2.1 on page 6.
- ▶ Adjust Windows printer setting ▷ 2.2 on page 6.



#### Attention!

▶ **Do not change the settings of the "IP" and "Gateway" on the printer web interface, as otherwise the connection to the printer may be lost.**

## 2 Connecting Label Printer to Computer

### 2.4.2 Installing a Hotspot

\* Access only with service Wi-Fi stick installed.



**Note!**

In that mode the Wi-Fi stick will be configured as a hotspot. That way a printer-own wireless network will be installed and the printer can be controlled and configured by a mobile device.

- ▶ Start menu.
- ▶ Select *Setup > Interfaces > Wi-Fi*.
- ▶ Activate *Wi-Fi* ▷ page 22.
- ▶ Select *Operation mode > Hotspot*.  
The new network gets a SSID generated of the *OEM name* and the last six digits of the MAC address and the password *hotspot!*. Both parameters can be changed if necessary.
- ▶ Select *Hotspot Info*.  
The display shows the IP address of the printer, the SSID and the password of the network and a QR code which can be scanned by a mobile device.



Figure 2 Hotspot info

- ▶ Scan the QR code.  
The mobile device will be connected with the printer hotspot.  
Alternatively the connection can be established using the *Settings* of the mobile device.  
Following the network services can be used depending on the settings of both devices.

## 2.5 Connecting Label Printer via USB Interface

The full-speed USB interface allows the label printer to be operated via a USB interface of a computer running one of the 32bit or 64bit operating systems:

- Windows Vista
- Windows 7
- Windows 8
- Windows 8.1
- Windows 10
- Windows Server 2008
- Windows Server 2008 R2
- Windows Server 2012
- Windows Server 2012 R2
- Windows Server 2016

A printer driver must be installed if a USB interface will be used for connection. The printer driver for the i5100 printer is found on the "Product CD" which is included in the box with the printer or on [www.BradyID.com/i5100](http://www.BradyID.com/i5100).

For detailed driver installation instructions with screen shot illustrations refer to the *Brady Driver Installation Guide* which can be downloaded from [www.BradyID.com/i5100](http://www.BradyID.com/i5100)



## 2 Connecting Label Printer to Computer

### 2.6 Driver Installation

If using Brady Workstation for creating labels, the drivers for i5100 will automatically be installed on the computer. If using LabelMark™ or any third party software, the drivers need to be installed manually

If Bonjour is not installed on your machine and is supported by your printer, it will be installed as part of the setup process

The printer driver install instructions cover two different manual installation scenarios

- Ethernet or Wi-Fi printing (network printer)
- USB driver only (local printer)

#### Instructions for Network Installation (Wi-Fi or Ethernet)

Use this installation process if you intend to send print jobs to the printer from the computer over a network. The printer must have Wi-Fi or Ethernet support in order to use this installation method.



#### Attention!

▶ Do not connect cables until instructed to do so!

1. Either insert the printer driver CD into the computer or double-click on the printer driver that you downloaded.
2. Select the *desired language* from the drop-down menu, then click *Next*.
3. Click *Install*.
4. Select the *Printer Model* for which the drivers are being installed, then click *Next*.
5. Power up the printer (if not already powered on) and wait for the printer to reach its home screen/ready screen.
6. Select *Wireless or Ethernet network connection*, then click *Next*.
  - Follow the instructions in your printer's user manual for setting up a network connection and connecting cables.
  - Refer to connection guidelines, shown below, to verify that the printer and PC are on the same network.

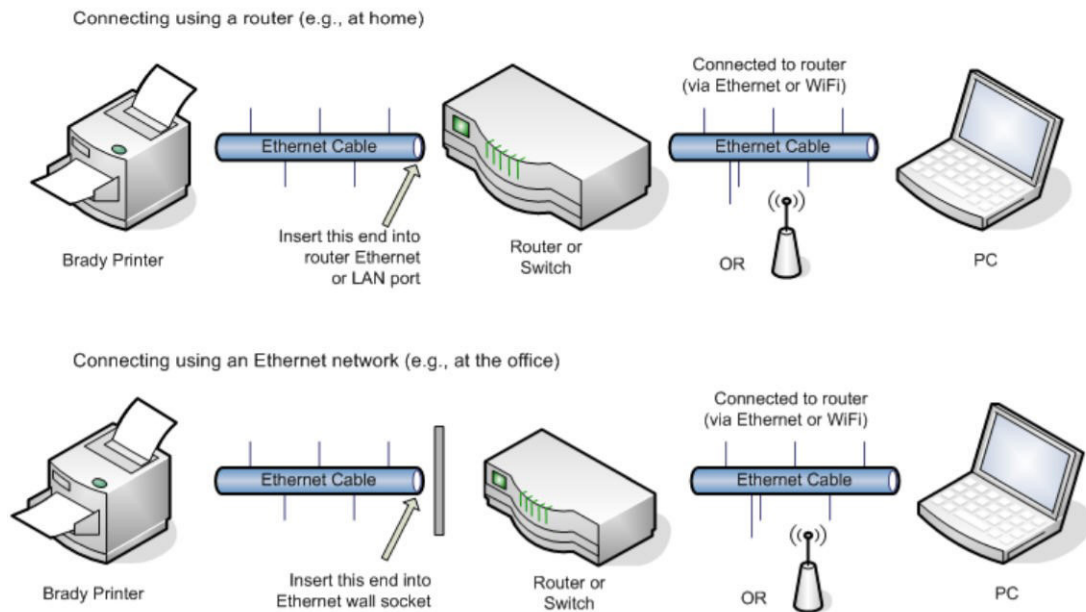

Figure 3 Connecting to a network

## 2 Connecting Label Printer to Computer

7. Follow on-screen instructions, then click **Next**.
  - The Bonjour program is designed to establish and monitor network printers. The Bonjour installation screens will not display if Bonjour is already installed on your computer.
  - To learn more about Bonjour print services for Windows, click the link in the *Installing Bonjour Print Services* screen (and click **Back** to return to the License Agreement screen).
8. Read the *Apple End User License Agreement* for Bonjour and click the box for *I accept the terms in the license agreement*, then click **Next**.
9. If Bonjour is supported by your printer, choose your **printer model name** from the list, then click **Next**.
  - Note: If the computer can communicate with the printer over *both* Wi-Fi and Ethernet it will randomly choose one of those connections. If you wish to specify the connection - Wi-Fi or Ethernet - either continue to the next step or disconnect the printer from the undesired interface and repeat step 9.
10. If the printer does not support Bonjour or you choose to add the printer manually, enter the printer's IP address or hostname and click **Next**.
11. Enter a name for the printer using up to 12 alphanumeric characters, then click **Next**...a progress bar will display while the printer driver is being installed.
  - Note the printer name you provide will only be seen on the computer onto which the drivers are being installed
12. Click **Finish** on the *Installation Complete Screen*.

### Instructions for Installing the USB Driver Only (local printer)

Use this installation process if you intend to send print jobs to the printer using a USB cable only.



#### Attention!

► **Do not connect cables until instructed to do so!**

1. Either insert the printer driver CD into the computer or double-click on the printer driver that you downloaded.
2. Select the **desired language** from the drop-down menu, then click **Next**.
3. Click **Install**.
4. Select the **Printer Model** for Installation, then click **Next**.
5. Power up the printer (if not already powered on) and wait for the printer to reach its home screen/ready screen.
6. Select **Using USB cable only**, then click **Next**.
7. Follow the on-screen instructions, then click **Next**.
  - Note: a message displays when the USB cable is connected and the printer driver installs automatically
  - A progress bar will display while the printer driver is being installed.
8. Click **Finish** on the *Installation Complete screen*.

### USB Connection Failed Error

If this error displays, the USB connection could have failed for the following reasons:

- The printer is powered off
- The USB cable is not connected
- The USB driver installation was not completed

If printer status indicates FAILED:

1. Ensure printer is powered on
2. Ensure USB cable is plugged securely into the ports OR disconnect the USB cable from the PC and try another port.
3. Click **Back** and try again

## 2 Connecting Label Printer to Computer

### 2.7 Connecting Label Printer via RS-232 interface

Pin	Designation	Function
1	CD	Carrier Detect
2	TxD	Transmit Data
3	RxD	Receive Data
4	DTR	Data Terminal Ready (not used)
5	GND	Ground
6	DSR	Data Set Ready (not used)
7	RTS	Request to Send
8	CTS	Clear to Send
9	RI	Ring Indication (not used)

Table 1 Pin assignment of the RS-232 interface

- ▶ Connect the 9-pin socket to the matching port of the computer.  
For the most computers a 9pin serial SUB-D cable with 1:1 wiring can be used.
- ▶ Install the Windows Printer Driver from the DVD included in the delivery contents of the printer.
- ▶ Configure the interface parameters of the interface matching to the settings of the computer. ▶ page 23.

### 2.8 Setting Up a Bluetooth Connection

To set up a Bluetooth connection a Bluetooth USB Adapter is required.



**Notice!**

**A Bluetooth software is delivered with the Bluetooth USB Adapter.**

1. Connect the Bluetooth USB adapter an to an USB master interface.
2. Switch on the printer.
3. Install the Bluetooth software on the computer.
4. Start the Bluetooth software.
5. Start "Search devices".  
The printer will be shown in a list of Bluetooth devices.
6. Optional : For an well-defined connection of the devices select the printer and click "Connect Devices".  
Either a passkey will be shown or a window will be opened where a passkey can be set.  
▶ Set a passkey if necessary .  
The display of the printer shows a prompt to enter the passkey too. ▶ Enter the passkey.
7. Select in the software "Connecting" via "Serial Bluetooth Interface".  
The new interface, e.g COM5, will be shown
8. Install the current printer with connection via the new COM interface in the label software or in Windows.

### 3 Menu

#### 3.1 Structure of the Menu

The menu contains setting options on several levels for configuring the label printer. In addition, the menu features test and diagnostic functions for supporting the configuration or checking the function of the label printer.

























1st Selection Level	2nd Selection Level	3rd Selection Level	
 Info			
 Storage			
 Setup	 Printing		
	 Labels		
	 Ribbon		
	 Tearing-off		
	 Cutting		
	 Peeling-off		
	 Interfaces	 Ethernet	
		 Wi-Fi	
		 Network services	
		 RS-232	
	 Errors		
	 Region		
	 Time		
	 Display		
	 Interpreter		
 ZPL			
 Test			
 Security			
 Diagnostics			
 Extras			
 Service			

Table 2 Structure of the menu

### 3 Menu

#### 3.2 Navigating in the Menu

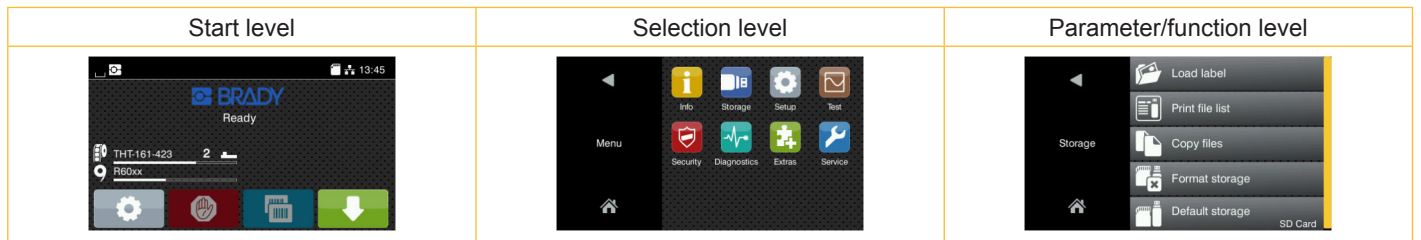





Figure 4 Menu levels

- ▶ To open the menu select  on the start screen.
- ▶ Select a theme in the selection level.  
Several themes have substructures again with selection levels.  
To return from the current level to the upper one select . To leave the menu select .
- ▶ Continue the selection until the parameter/function level is reached.
- ▶ Start a function. The printer will carry out the function possibly after a preparing dialogue.  
- or -  
Select a parameter to set. The setup possibilities are depending from the parameter type.

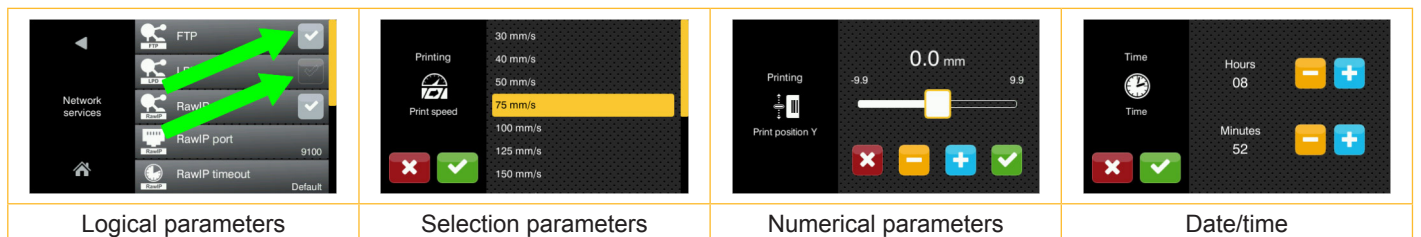

Figure 5 Samples for parameter setting







	Scroll bar for rough value setting
	Decreasing the value step-by-step
	Increasing the value step-by-step
	Return without saving the setting
	Return with saving the setting
	Parameter is disabled, touching enables the parameter
	Parameter is enabled, touching disables the parameter

Figure 6 Buttons for parameter setting

## 3 Menu

### 3.3 Service Key

A service key is required for accessing special service functions not accessible to the operator. This key switches the printer to service mode and enables:

- Access to additional configuration parameters
- Resetting of the service counter
- Additional information in the status print and in the device list
- Changing of the device name
- Access to PIN-protected configuration parameters and functions without entering the PIN
- Access to configuration parameters for optional assemblies, even if they are not currently installed

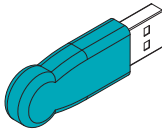

Figure 7 Service key



#### **Attention!**

**Incorrect settings and data loss via unauthorized access.**

**Access protection is deactivated when the service key is inserted. Operation of the printer by unauthorized persons can lead to incorrect settings and data loss in this case.**

- ▶ **Provide the service key to authorized persons only.**
- ▶ **Remove service key after service work and store it in a secure location.**

- ▶ Insert service key into a USB master interface of the printer.

The service key also can be inserted while the device is switched on.



#### **Notice!**

**In this document, parameters and functions which are only accessible when the service key is inserted are indicated using the following note:**

 **Access only with service key inserted!**

## 4 Info

The  *Info* function provides an overview of important status information on the display of the printer.

- ▶ Start menu.
- ▶ Select *Info*.
- ▶ Return with *Close*.

The following parameters are displayed:

Line	Meaning	Example
1	Printer type Version number and creation date of the firmware	<b>i5100-300</b> Firmware V5.14 Feb 09, 2018
2	IPv4 address of the printer when connected to a network via Ethernet MAC address of the network adapter on the PCB CPU	<b>Ethernet</b> IPv4 10.255.255.2 MAC 00:02:e7:05:bb:9d
3	IPv4 address of the printer when connected to a network via Wi-Fi MAC address of the Wi-Fi adapter	<b>Wi-Fi</b> IPv4 172.20.200.43 MAC e8:4e:06:3e:6f:bc
4	Zeroconf host name	<b>mDNS</b> brady-05bb9d.local
5	Operative time and number of printed labels	<b>Hours/no. of labels</b> 26h/2924
6	Previously printed paper lengths with thermal direct printing / thermal transfer printing	<b>Thermal/Transfer</b> 0.00m/209.57m
7	Resolution, number of dots and revision of the printhead	<b>Printhead</b> 300dpi, 1248dots Rev. 2.1.0
8	Results of the label sensor calibration	<b>Label sensor</b> Brightness 2-4 / 22-139
9	Serial number of the PCB CPU, Revision of PCB CPU and the FPGA	<b>PCB</b> S/N 164162032326 PCB Rev. 0 FPGA Rev. 13

Table 3 *Info* display

## 5 Security

In the  Security menu the access rights for several printer function can be set.

- ▶ Start menu.
- ▶ Select Security.









Parameter	Meaning	Default
 PIN protection	Password to protect certain parameters and functions accessible by the control panel.	0000
 Password ftpprint	Password for FTP printing ▶ Login as ftpprint * Access only when <i>Interfaces &gt; Network services &gt; FTP = "On"</i>	print
 Password ftpcard	Password for FTP access to storage devices (USB stick, SD card, IFFS) ▶ Login as ftpcard * Access only when <i>Interfaces &gt; Network services &gt; FTP = "On"</i>	card
 Password ftpadmin	Password for FTP firmware update ▶ Login as ftpadmin * Access only when <i>Interfaces &gt; Network services &gt; FTP = "On"</i>	admin
 Password website	Password for Parameter setting via web interface ▶ Login as admin * Access only when <i>Interfaces &gt; Network services &gt; Website = "On"</i>	admin
 Security web service	Authentication type for the SOAP protocol * Access only when <i>Interfaces &gt; Network services &gt; Web service = "On"</i>	Digest
 Password web service	Password for the SOAP protocol * Access only when <i>Interfaces &gt; Network services &gt; Web service = "On"</i>	soap
 Password VNC	Password for the VNC server * Access only when <i>Interfaces &gt; Network services &gt; VNC server = "On"</i>	vnc

Table 4 Parameters of the Security menu



## 6 Configuration

### 6.1 Configuration via Control Panel

A host of parameters for configuring the printer are found in the *Setup* menu.

- ▶ Configure the printer via the control panel during initial commissioning and when making major changes to the operational conditions.
- ▶ For changes required for processing different print jobs use software settings.







**Notice!**

The *Setup* menu can be protected from unauthorized access via a code number (PIN).

#### 6.1.1 Printing

- ▶ Start menu.
- ▶ Select *Setup > Printing*.

Parameter	Meaning	Default
 <i>Heat level</i>	<p>Heating value for compensating for the differing thermal behavior of printheads. Changing this value is then especially necessary if the printing intensity has changed after replacing the printhead.</p> <ul style="list-style-type: none"> <li>▶ To adapt the printing intensity when using different media, print speeds or printing contents, you should change the heat level in the software.</li> </ul> <p>The settings of configuration and software are added together. The <i>Heat level</i> setting also affects the test printouts.</p>	0
 <i>Print speed</i>	<p>Basic print speed setting.</p> <p>The print speed can be re-specified for each print job via software. The basic setting is not changed by this.</p> <p>The print speed setting also affects the test printouts.</p>	100 mm/s
 <i>Print position X</i>	<p>Shifting of the entire print image perpendicular to the direction of paper flow.</p> <p>The absolute shifting is limited by the margins of the print zone. Those are determined by the width of the printing line on the printhead.</p> <p>The setting can also be adjusted by the software.</p> <p>The settings of configuration and software are added together.</p>	0.0 mm
 <i>Print position Y</i>	<p>Shifting of the entire print image in the direction of paper flow. With positive values, printing begins later in the direction of paper flow.</p> <p>Shifting of the print image in the direction of paper flow also influences the peel and cut positions.</p> <ul style="list-style-type: none"> <li>▶ Correct the <i>Peel position</i> and <i>Cut position</i> parameters by the same value in the opposite direction.</li> </ul> <p>The setting can also be adjusted by the software.</p> <p>The settings of configuration and software are added together.</p>	0.0 mm

## 6 Configuration











Parameter	Meaning	Default
 <b>Backfeed</b>	<p>Method for backfeeding the label medium.</p> <p>Backfeeding is necessary in the cutting and peel-off modes since a label is pushed out passed the front edge of the next label above the print line when peeling off/cutting.</p> <p><i>always:</i> Backfeeding occurs independently of label contents.</p> <p><i>smart:</i> Backfeeding only occurs when the next label is not yet completely prepared when peeling off/cutting the current label. Otherwise, the second label is pushed on and completed after removal of the first label without backfeeding.</p>	<i>smart</i>
 <b>Backfeed position</b>	Offset of the backfeed movement	1.0 mm
 <b>Print on demand</b>	<p>Peel-off mode : Behavior after removing a label from the peel position</p> <p><i>On:</i> The next label will be printed and peeled-off after touching </p> <p><i>Off:</i> The next label will be printed and peeled-off immediately</p>	<i>Off</i>
	<p>Cut mode : Behavior between the cuts</p> <p><i>On:</i> After cutting the next label will be printed and cut after touching </p> <p><i>Off:</i> All labels will be printed and cut nonstop</p>	
 <b>Reprint</b>	<p>Printing of another label with the information of the previous print job by touching .</p> <p>This function can be executed until the print buffer is cleared with .</p> <p><i>Re-render:</i> Adaption of counter values, variable data can be newly put in.</p> <p><i>Duplicate:</i> New label is identical with the last label of the print job.</p> <p><i>Off:</i> No reprint</p>	<i>Re-render</i>
 <b>Length scale</b>	Eliminate deviations of the print length from the length set in the programming	0,0%
 <b>Slippage correction</b>	To correct the slippage of the media transport the positioning of the print image will be re-adjusted to the position of the last detected label front edge considering the programmed label distance.	<i>Off</i>

Table 5 Parameters of the Setup > Printing menu

## 6 Configuration

### 6.1.2 Labels

- ▶ Start menu.
- ▶ Select *Setup > Labels*.



Parameter	Meaning	Default
 <i>Label sensor</i>	Method for detecting the starting end of the label. <i>Gap Sensor:</i> Detection using changes in the transparency between the label and label gap. <i>Bottom-Reflect:</i> Detection using reflex marks on the bottom of the medium. <i>Continuous media:</i> Checking the existence of media only.	<i>Gap sensor</i>
 <i>Extrapolate labels</i>	The positions of the labels which are between the label sensor and the printhead are calculated from the first label recognized by the sensor and the programmed label distance. That way those labels can be printed although the printhead previously was open.	<i>Off</i>

Table 6 Parameters of the *Setup > Labels* menu

### 6.1.3 Ribbon

- ▶ Start menu.
- ▶ Select *Setup > Ribbon*.





Parameter	Meaning	Default
 <i>Transfer print</i>	<i>On:</i> Sensor for monitoring the transfer ribbon is activated. <i>Off:</i> Sensor for monitoring the transfer ribbon is not activated. The setting can be overwritten for each print job via software. The basic setting is not changed by this.	<i>On</i>
 <i>Warn level ribbon</i>	Threshold diameter (32–74 mm) of the ribbon supply roll, if the value is undershot the "ribbon low" message will be activated	<i>Off</i>
 <i>Pause on warning</i>	The print job will be interrupted when the "ribbon low" message appears	<i>Off</i>
 <i>Monitor ink side</i>	Setting of the ribbon unwinding direction The print job will be interrupted when the wrong ribbon winding direction has been detected. The error message "Ribbon ink side" appears.	<i>Off</i>

Table 7 Parameters of the *Setup > Ribbon* menu

## 6 Configuration

### 6.1.4 Tearing-off

- ▶ Start menu.
- ▶ Select *Setup > Tearing-off*.



Parameter	Meaning	Default
 <i>Tear-off mode</i>	Positioning the label medium for tearing off at the tear-off plate. <i>On</i> : Additional advancement of the label medium which positions the label gap after the last printed label at the dispense plate. <i>Off</i> : Label advance stops once the last label has fully passed the print line.	<i>On</i>
 <i>Tear-off position</i>	Shifting of the tear-off position in the direction of paper flow. With positive values, the label strip is transported farther out of the printer.	<i>0.0 mm</i>

Table 8 Parameters of the *Setup > Tearing-off* menu

### 6.1.5 Cutting

\*  If cutter is not installed, access only with service key inserted.

- ▶ Start menu.
- ▶ Select *Setup > Cutting*.

Parameter	Meaning	Default
 <i>Cut position</i>	Offset of the cut position relative to the rear label edge. The setting can also be adjusted by the software. The settings of configuration and software are added together.	<i>0.0 mm</i>

Table 9 Parameters of the *Setup > Cutting* menu

### 6.1.6 Peeling-off

\*  If peel-off module is not installed, access only with service key inserted.

- ▶ Start menu.
- ▶ Select *Setup > Peeling-off*.



Parameter	Meaning	Default
 <i>Peel-off position</i>	Shift the position of the dispensed label relative to the dispensing edge. The setting can also be adjusted by the software. The settings of configuration and software are added together.	<i>0.0 mm</i>
 <i>Backfeed delay</i>	Delay time between removing the label from the peel position and the backfeed of the label.	<i>250 ms</i>

Table 10 Parameters of the *Setup > Peeling-off* menu

## 6 Configuration

### 6.1.7 Interfaces

- ▶ Start menu.
- ▶ Select *Setup > Interfaces*.

#### Ethernet







Parameter	Meaning	Default
 <i>Hostname</i>	Unique identification of the printer in a network in a human readable format	<i>generated of OEM name and the last six digits of the MAC address</i>
 <i>DHCP</i>	Method of issuing IP address <i>On</i> : Dynamic issuing of IP address by the DHCP server <i>Off</i> : Direct issuing of the IP address by the operator	<i>On</i>
 <i>&gt; IP address</i>	IP address of the label printer. Only valid with <i>DHCP = Off</i> .	-
 <i>&gt; Netmask</i>	Subnet mask (classification and address range) of the local network. Only valid with <i>DHCP = Off</i> .	-
 <i>&gt; Gateway</i>	Connection address between the local network and other networks.	<i>Off</i>
 <i>&gt;&gt; Gateway address</i>	The IP address of the computer (router) on the network through which the connection can be established is used for this. The address of the router can also be issued via DHCP.	-
 <i>&gt; DNS-Server</i>	Setting the IP address of a DNS server manually The DNS server resolves the internet addresses to IP addresses e.g. to select network services such as NTP per domain name.	-

Table 11 Parameters of the *Setup > Interfaces > Ethernet* menu

## 6 Configuration

### Wi-Fi

\* Access only with Wi-Fi stick installed.













Parameter	Meaning	Default
 <i>Wi-Fi</i>	Activation of the Wi-Fi interface	<i>Off</i>
 > <i>Operation mode</i>	Selection of the operation mode <i>Connect to network:</i> Connection of the printing to an existing wireless network <i>Hotspot:</i> Installation of a printer-own wireless network to connect mobile devices to the printer	<i>Connect to network</i>
Operation mode <i>Connect to network</i>		
 >> <i>Access-Point</i>	Selection of the Access Point to setting up the Wi-Fi connection.	-
 >> <i>DHCP</i>	▷ <i>Ethernet &gt; DHCP</i>	<i>On</i>
 >>> <i>IP adress</i>	▷ <i>Ethernet &gt; IP adress</i>	-
 >>> <i>Netmask</i>	▷ <i>Ethernet &gt; Netmask</i>	-
 >>> <i>Gateway</i>	▷ <i>Ethernet &gt; Gateway</i>	<i>Off</i>
 >>>> <i>Gateway address</i>	▷ <i>Ethernet &gt; Gateway address</i>	-
 >>> <i>DNS-Server</i>	▷ <i>Ethernet &gt; DNS-Server</i>	-
Operation mode <i>Hotspot</i>		
 >> <i>Hotspot SSID</i>	Name of the printer-own wireless network	generated of the <i>OEM name</i> and the last six digits of the MAC address
 >> <i>Hotspot password</i>	Password of the printer-own wireless network	<i>hotspot!</i>
 >> <i>Hotspot info</i>	Display of the IP adress of the hotspot, the SSID and the password Display of a QR code, which can be scanned with a mobile device to connect the device to the printer-own wireless network	-

Table 12 Parameters of the *Setup > Interfaces > Wi-Fi* menu

## 6 Configuration



### Network Services

Parameter	Meaning	Default
<i>FTP</i>	Activation of the File Transfer Protocol	<i>On</i>
<i>LPD</i>	Activation of the network printing service LPD	<i>On</i>
<i>RawIP</i>	Activation of the network printing service RawIP and selection of the port address	<i>On</i>
<i>&gt; RawIP Port</i>	Selection of the port address for RawIP	<i>9100</i>
<i>&gt; RawIP Timeout</i>	Setting the timeout for the interruption of unused connections	<i>Default</i>
<i>Website</i>	Activation of the Hypertext Transfer Protocol for the access to the internal printer website	<i>On</i>
<i>Web service</i>	Activation of the Simple Object Access Protocol	<i>Off</i>
<i>SNMP</i>	Data exchange between printer and management station via Simple Network Management Protocol	<i>Off</i>
<i>&gt; SNMP community</i>	Keyword to assign the SNMP rights	<i>public</i>
<i>VNC server</i>	Activation of the VNC server for remote access to the control panel	<i>Off</i>
<i>Zeroconf</i>	Activation of the auto-configuring Zeroconf method for adhoc networks	<i>Off</i>

Table 13 Parameters of the *Setup > Interfaces > Network services* menu



### RS-232

Parameter	Meaning	Default
<i>Baud rate</i>	Speed (in Baud) of data transfer	<i>115.200</i>
<i>Handshake</i>	Data transfer protocol	<i>RTS/CTS</i>

Table 14 Parameters of the *Setup > Interfaces > RS-232* menu



#### Note!

The following parameters cannot be changed: **Data bits: 8, Stop bits: 1, Parity: None**

## 6 Configuration

### 6.1.8 Errors

- ▶ Start menu.
- ▶ Select *Setup > Errors*.





Parameter	Meaning	Default
 <i>Error-Reprint</i>	<i>On</i> : With a correctable error and corresponding troubleshooting, the label being printed when the error occurs is repeated. <i>Off</i> : Print job is continued with the next label.	<i>On</i>
 <i>Syntax error</i>	Printer switches to error mode after receipt of an incorrect command.	<i>On</i>
 <i>Barcode error</i>	<i>On</i> : With faulty barcode contents or size specifications, printing is interrupted. <i>Off</i> : Printing is not interrupted if an error occurs. If barcode contents are faulty, the printer attempts to replace the incorrect data with valid characters (e.g. zeros). If barcode size specifications are faulty, a gray area is printed instead of the barcode.	<i>On</i>
 <i>Network error</i>	Printer switches to error mode when problems with the network connection occur.	<i>Off</i>

Table 15 Parameters of the *Setup > Errors* menu

### 6.1.9 Region

- ▶ Start menu.
- ▶ Select *Setup > Region*.



Parameter	Meaning	Default
 <i>Language</i>	Setting the display language	<i>English</i>
 <i>Country</i>	Setting the country-specific date and time formats. The time formats can also be overwritten via software. The changes are not saved permanently, however.	<i>Germany</i>
 <i>Keyboard</i>	Setting of the keyboard layout when using an external keyboard or the soft keyboard on the printer display.	<i>Automatic (=Country)</i>

Table 16 Parameters of the *Setup > Region* menu



## 6 Configuration

### 6.1.10 Time

- ▶ Start menu.
- ▶ Select *Setup > Time*.







Parameter	Meaning	Default
 <i>Date</i>	Setting of the system date. The print output of the date occurs in the format set via the <i>Country</i> parameter.  The date can also be changed via software. The change is not saved permanently, however.	-
 <i>Time</i>	Setting the system time. When changing the time, ensure that the <i>Timezone</i> , <i>Daylight saving</i> and <i>Date</i> parameters are set correctly. The time can also be synchronized automatically via the internet using the Ethernet interface. The print output of the time occurs in the format set via the <i>Country</i> parameter. The time can also be changed via software. The change is not saved permanently, however.	-
 <i>Time zone</i>	Adaptation of the time display of the printer to the time zone in relation to UTC (Universal Time Coordinated).	<i>UTC+1</i>
 <i>Daylight saving</i>	Selection of the daylight saving regulation applicable for the region. The time is then changed automatically.	<i>EU</i>
 <i>Time synchronisation</i>	Activation of a service to synchronize date and time of the printer.	<i>NTP</i>
 <i>&gt; Time server</i>	Address of the time server	

Table 17 Parameters of the *Setup > Time* menu

## 6 Configuration

### 6.1.11 Display

- ▶ Start menu.
- ▶ Select *Setup > Display*.



Parameter	Meaning	Default
 <i>Brightness</i>	Brightness of the LCD display.	8
 <i>Time powersave</i>	Time between the last operation and activation of energy-saving mode.	5 min

Table 18 Parameters of the *Setup > Display* menu

### 6.1.12 Interpreter

- ▶ Start menu.
- ▶ Select *Setup > Interpreter*.







Parameter	Meaning	Default
 <i>Character set</i>	Selection of the character set table for adaptation to the computer system used. Switching the character set via software is not possible. Characters not available in the selected character set can be accessed using the Unicode table.	UTF-8
 <i>USB</i>	Choosing between the programming languages JScript and ZPL for data transfer via USB interface	JScript
 <i>RS-232</i>	Choosing between the programming languages JScript and ZPL for data transfer via RS-232 interface	JScript
 <i>FTP</i>	Choosing between the programming languages JScript and ZPL for data transfer via FTP	JScript
 <i>LPD</i>	Choosing between the programming languages JScript and ZPL for printing with LPD	JScript
 <i>RawIP</i>	Choosing between the programming languages JScript and ZPL for printing with RawIP	JScript
 <i>Bluetooth</i>	Choosing between the programming languages JScript and ZPL for data transfer via Bluetooth * only with Bluetooth adapter installed	JScript

Table 19 Parameters of the *Setup > Interpreter* menu

### 6.1.13 ZPL

- ▶ Start menu.
- ▶ Select *Setup > ZPL*.



Parameter	Meaning	Default
 <i>&gt; Printing width</i>	Setting the print width for ZPL programming	100.0 mm
 <i>&gt; Label length</i>	Setting the label length for ZPL programming	150.0 mm

Table 20 Parameters of the *Setup > ZPL* menu

## 6 Configuration

### 6.2 Configuration via the Web Interface

The parameters accessible via the control panel can also be set via the web interface contained in the firmware of the printer.

The printer web interface can be accessed with a browser (e.g. Microsoft Internet Explorer, Mozilla Firefox) with JavaScript activated via the Ethernet interface or the optional Wi-Fi interface.

#### Calling Up the Web Interface



#### **Attention!**

**Whenever settings are changed via the web interface you are requested to enter the user name "admin" and a password. The default value of the password is also "admin". The password can be changed via the web interface (▷ "Setup Tab" page 29).**

- ▶ Start the browser.
- ▶ Call the web interface by entering the IP address via HTTP (e.g. <http://10.255.255.2>).  
The "Status" tab is open on the home screen.

The web interface contains the following tabs:

- Status: general status description ▷ page 28.
- Setup: configuration parameter settings ▷ page 29.
- Security: password settings ▷ page 30.
- Devices: list of the hardware and optional components ▷ page 31.
- Fonts: overview of the available fonts ▷ page 32.

## 6 Configuration

### 6.2.1 Status Tab

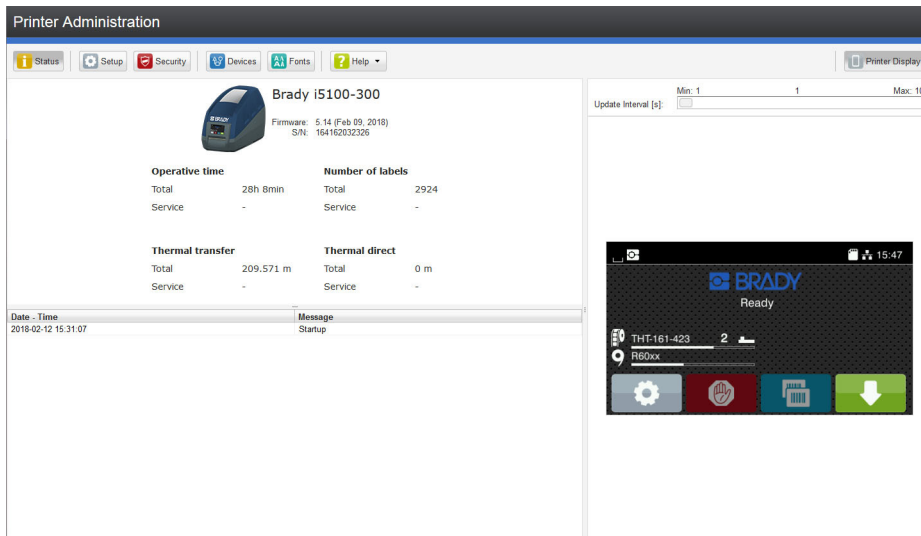

Figure 8 "Status" tab on the printer web interface

The following information is contained in the left top section of the "Status" tab:

- Printer type
- Firmware version
- Serial number of the PCB CPU
- Operative time of the printer
- Number of labels printed since commissioning
- Previously printed paper length with thermal transfer printing
- Previously printed paper length with thermal direct printing

A list of the events which have occurred since the printer was switched on is to be found in the left bottom section of the tab.

The right section of the tab shows the current printer display information.



**Notice!**

By clicking the buttons the printer can be operated in the same manner as by using the touchscreen on the device.

When the printer display is selected by mouse click, it is possible to use the computer keyboard in the same manner like an External Keyboard (▷ 14.3 on page 59) e.g. for entering variable input data.

## 6 Configuration

### 6.2.2 Setup Tab

On the "Setup" tab all the configuration parameters can be set which are also accessible via the control panel in the Setup menu.

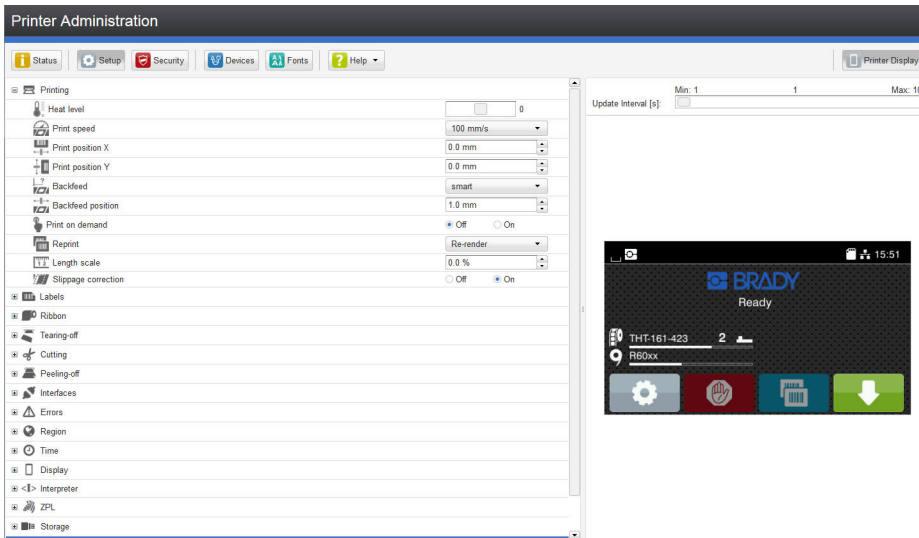

Figure 9 "Setup" tab on the printer web interface

To change a parameter:

1. Locate parameter in the tree structure.
2. Set the value of the parameter at the right end of the concerning line.  
A prompt to enter user name and password appears ▷ page 16.
3. Enter user name and password and click **OK**.

## 6 Configuration

### 6.2.3 Security Tab

On the "Security" tab the access rights for several printer function can be set. The tab contains the same parameters as the *Security* menu of the Setup ▸ page 16.

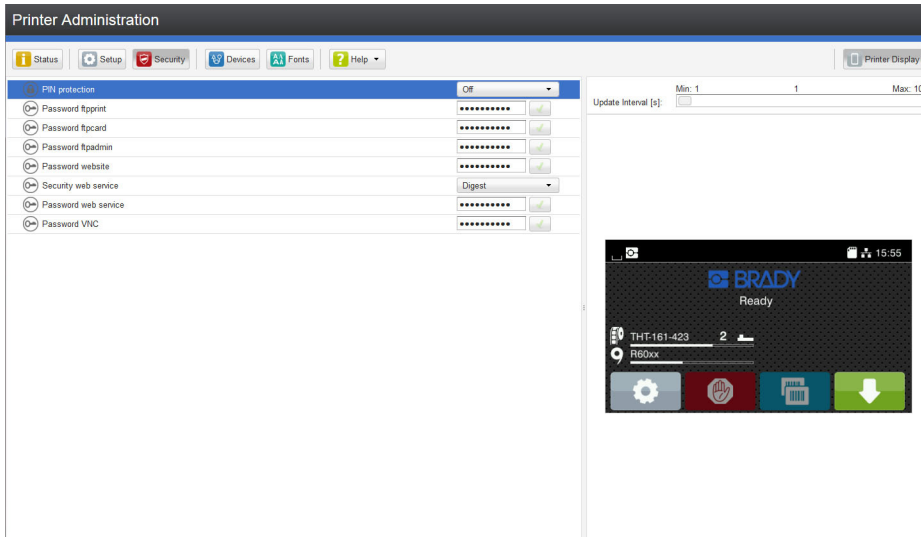

Figure 10 "Security" tab on the printer web interface

To change a parameter:

1. Locate parameter in the tree structure.
2. Set the value of the parameter at the right end of the concerning line.  
A prompt to enter user name and password appears ▸ page 16.
3. Enter user name and password and click **OK**.

## 6 Configuration

### 6.2.4 Devices Tab

The "Devices" tab provides an overview of the most important hardware components installed in the printer and the optional devices connected.

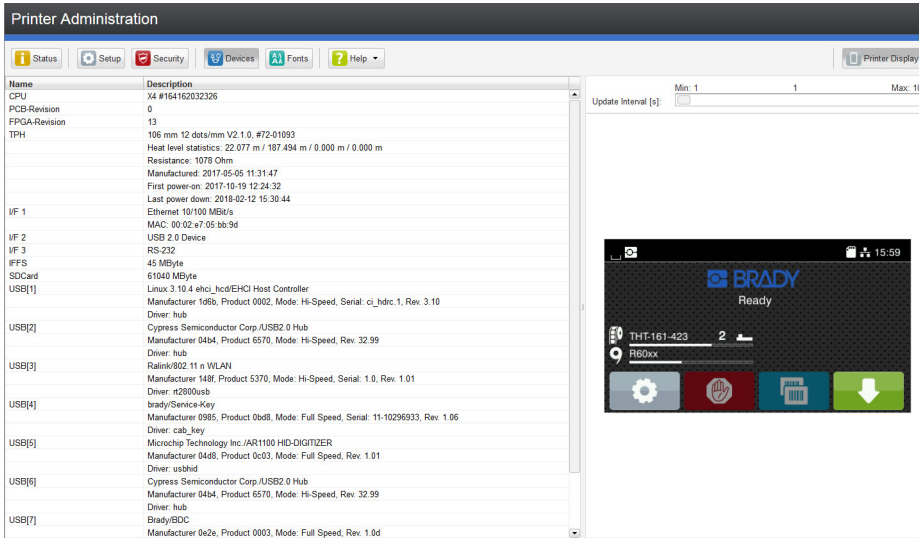

Figure 11 "Devices" tab on the printer web interface

The contents of the display correspond with those of the *Device list* ▶ Table 22 on page 36.

## 6 Configuration

### 6.2.5 Fonts Tab

The most important parameters of the fonts available in the printer are listed on the "Fonts" tab. The table contains both the original fonts in the printer and other fonts loaded into the printer.

Description	Name	JScript ID	Origin	Format
Default Font 12x12 dots	_DEF1	-1	System Font	Bitmap
Default Font 16x16 dots	_DEF2	-2	System Font	Bitmap
Default Font 16x32 dots	_DEF3	-3	System Font	Bitmap
OCR-A Size I	OCR_A_I	-4	System Font	Bitmap
OCR-B	OCR_B	-5	System Font	Bitmap
Swiss 721	BX000003	3	System Font	TrueType
Swiss 721 Bold	BX000005	5	System Font	TrueType
Monospace 821	BX000596	596	System Font	TrueType
AR Heli Medium GB-Mono	GHEI21M	1000	System Font	TrueType
HanWangHeLight	HANWANG	1001	System Font	TrueType
Garuda	GARUDA	1010	System Font	TrueType

Figure 12 "Fonts" tab on the printer web interface

The parameters correspond to those in the *Font list* ▸ Table 21 on page 35.



## 6 Configuration

### 6.2.6 Help Menu

Independent from the chosen tab some help functions can be selected :

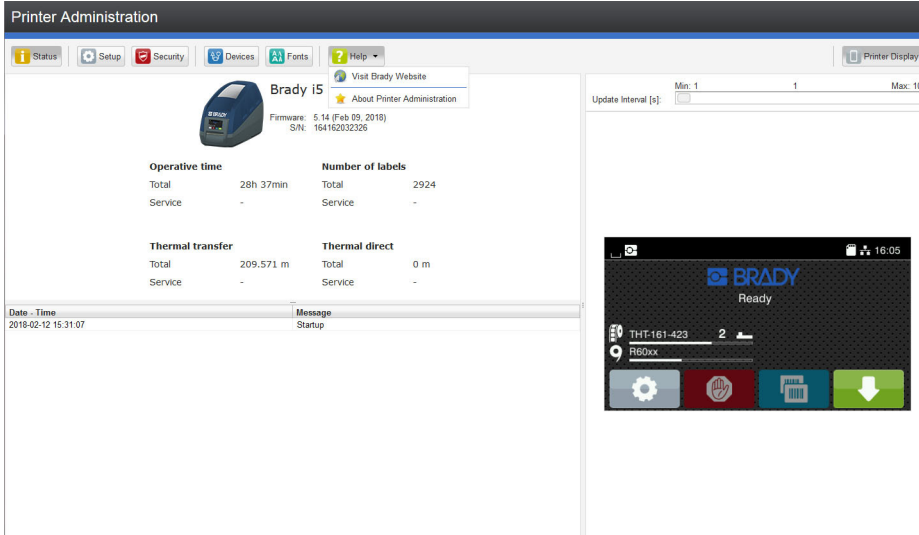

Figure 13 "Help" menu on the printer web interface



Visit the Brady Website.



Information about the version and the latest alterations of the web interface.

## 7 Test Functions

### 7.1 Overview

The  *Test* menu contains test functions providing information on:

- the most important configuration parameters
- the fonts available in the printer
- important hardware components and connected peripheral devices
- the print image quality and state of the thermal printhead
- available Wi-Fi networks.

### 7.2 Status Print

The *Status print* function prints a test image containing information on the configuration and status of the printer. The printout occurs using the heat level and print speed specified in the *Setup > Printing* menu.



#### Notice!

**The printout occurs without taking the label gaps into consideration. This is why endless media are most suitable for this purpose.**

- ▶ Insert printable medium (labels, endless paper) which extends across the entire printing width.
- ▶ If the printout is to occur using thermal transfer printing, insert transfer ribbon with the maximum width.
- ▶ Start menu.
- ▶ Select *Test > Status print*.

The printout can be canceled with .

Status print	
Tue Feb 13 10:28:21 2018 Brady i5100-300 Firmware V5.14 (Feb 09, 2017) - #164162032326	
<b>Printing</b>	Heat level 0 Print speed 75 mm/s Print position X 0.0 mm Print position Y 0.0 mm Backfeed smart Backfeed position 1.0 mm Print on demand Off Reprint Re-render Length scale 0.0 % Slippage correction Off
<b>Labels</b>	Label sensor Gap Extrapolate labels Off
<b>Ribbon</b>	Transfer print On Warn level ribbon 32 mm Pause on warning Off Monitor ink side Off
<b>Tearing-off</b>	Tearing-off mode On Tearing-off position 0.0 mm
<b>Cutting</b>	Cut position 0.0 mm
<b>Peeling-off</b>	Peel-off position 0.0 mm Backfeed delay 250 ms
<b>Interfaces</b>	<b>Ethernet</b> Hostname brady-05bb9d DHCP Off IP address 192.168.9.13 Netmask 255.255.255.0 Gateway Off DNS server 0.0.0.0 <b>Wi-Fi</b> Wi-Fi On Access Point guest DHCP Off IP address 172.20.200.93 Netmask 255.255.255.0 Gateway Off DNS server 0.0.0.0
<b>Network services</b>	FTP On LPD On RawIP On RawIP port 9100 RawIP timeout Default Website On Web service On SNMP On SNMP community public VNC server On Zeroconf On <b>RS-232</b> Baud rate 115200 Handshake RTS/CTS
<b>Errors</b>	Error-Reprint On Syntax error On Barcode error On Network error On
<b>Region</b>	Language English Country USA Keyboard Automatic
<b>Time</b>	Date 02/13/2018 Time 10:28:21 AM Time zone UTC-6 (Central Am.,Chicago) Daylight saving USA Time synchronization NTP Time server
<b>Display</b>	Brightness 8 Time powersave 5 min
<b>Interpreter</b>	Character set UTF-8 USB JScript RS-232 JScript FTP JScript LPD JScript RawIP JScript Bluetooth JScript
<b>ZPL</b>	Print width 100.0 mm Label length 150.0 mm
<b>Storage</b>	Default storage SD Card
<b>Security</b>	PIN protection On
<b>Extras</b>	Cleaning interval 1000 m
<b>Service</b>	Printhead zero pos. X 0.0 mm Printhead zero pos. Y 0.0 mm
<b>Printer Info</b>	Operative time Total 32h 53min Service - Number of labels Total 2928 Service - Thermal transfer Total 32.517 m Service 20.154 m Thermal direct Total 212.275 m Service - Temperature 25.9 °C Heat voltage 24.1 V Heat level < 0 22.077 m 0-7 190.198 m 8-14 0.000 m > 14 0.000 m Label sensor Brightness 2-4 / 22-139

Figure 14 Status print  
Parameters marked *italic* are only printed when the printer is equipped with the respective optional assembly or when the service key is inserted

## 7 Test Functions

### 7.3 Font list

The *Font list* function prints the most important parameters of the fonts available in the printer in tabular form. The table contains both the original fonts in the printer and other fonts loaded into the printer. The printout occurs using the heat level and print speed specified in the *Setup > Printing* menu.



**Notice!**

**The printout occurs without taking the label gaps into consideration. This is why endless media are most suitable for this purpose.**

- ▶ Insert printable medium (labels, endless paper) which extends across the entire printing width.
- ▶ If the printout is to occur using thermal transfer printing, insert transfer ribbon with the maximum width.
- ▶ Start menu.
- ▶ Select *Test > Font list*.

The printout can be canceled with .

Font list			
Tue Jan 13 10:52:06 2018			
Brady i5100-300			
Firmware V5.14 (Feb 09, 2018) - #164162032326			
No.	Name	Type	Description
-1	_DEF1	Bitmap	Default Font 12x12 dots
-2	_DEF2	Bitmap	Default Font 16x16 dots
-3	_DEF3	Bitmap	Default Font 16x32 dots
-4	OCR_A_I	Bitmap	OCR-A Size I
-5	OCR_B	Bitmap	OCR-B
3	BX000003	TrueType	Swiss 721
5	BX000005	TrueType	Swiss 721 Bold
596	BX000596	TrueType	Monospace 821
1000	GHEI21M	TrueType	AR Heiti Medium GB-Mono
1010	GARUDA	TrueType	Garuda

Figure 15 Font list

Column	Meaning
No.	ID number of the font required for programming (command T).
Name	Name with which the font is saved internally.
Type	Type of font generation. It provides information on the variability of the font and is important when programming (command T).
Description	Explanations of the font: size, font family. The printout occurs in the appropriate font.

Table 21 Parameters of the *Font list*

## 7 Test Functions

### 7.4 Device List

The *Device list* function prints out the most important information on hardware components of the printer and connected devices. The printout occurs using the heat level and print speed specified in the *Setup > Printing* menu.



#### Notice!

The printout occurs without taking the label gaps into consideration. This is why endless media are most suitable for this purpose.

- ▶ Insert printable medium (labels, endless paper) which extends across the entire printing width.
- ▶ If the printout is to occur using thermal transfer printing, insert transfer ribbon with the maximum width.
- ▶ Start menu.
- ▶ Select *Test > Device list*.

The printout can be canceled with

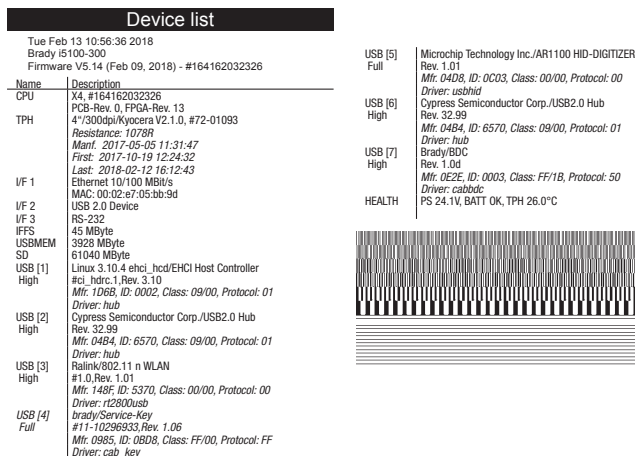

Figure 16 Device list  
Parameters marked *italic* are only printed when the service key is inserted

Name	Information
CPU	Type and serial number of the PCB CPU Revision of PCB CPU and FPGA
TPH	Print width and resolution of the installed thermal printhead
IF [x]	Type of interfaces installed <b>x</b> : Number of interface
IFFS	Size of the Internal Flash File System
USBMEM	Size and type of an installed USB storage device
SD	Size and type of an installed SD card
USB [a] Speed	Type and revision of installed USB devices <b>a</b> : number of USB device <b>Speed</b> : data transfer speed (low, full, high)  The following properties are only displayed when the service key is inserted: <b>Mfr.</b> : Manufacturer ID. This identifies the manufacturer of the USB device <b>Class</b> : Code for the USB device class <b>Protocol</b> : Code for the type of communication with the USB device <b>Phase</b> : Internal value for troubleshooting
HEALTH	Printhead voltage, charge state of the lithium battery on the PCB CPU, temperature of CPU and printhead
Line pattern	Lines differing in thickness at various distances. They are used to evaluate the print quality.

Table 22 Parameters of the *Device list*

## 7 Test Functions

### 7.5 Test Grid

The *Test grid* function prints out a geometric pattern on a background grid. This allows you to assess the evenness of the print quality.

The printout occurs using the heat level and print speed specified in the *Setup > Printing* menu.



#### Notice!

**The printout occurs without taking the label gaps into consideration. This is why endless media are most suitable for this purpose.**

- ▶ Insert printable medium (labels, endless paper) which extends across the entire printing width.
- ▶ If the printout is to occur using thermal transfer printing, insert transfer ribbon with the maximum width.
- ▶ Start menu.
- ▶ Select *Test > Test grid*.  
The geometric pattern is printed every 3 seconds once the Test grid function is started.

The printout can be canceled with .

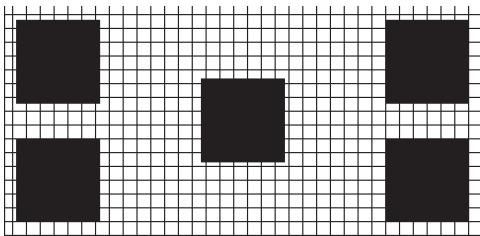

Figure 17 Test grid

## 7 Test Functions

### 7.6 Wi-Fi Status

- \* **Access only when a Wi-Fi stick is installed and Wi-Fi is activated! Not in the Wi-Fi operation mode "Hotspot".**

The *Wi-Fi status* function prints out a list with the most important parameters of the accessible Wireless Access Points. The printout occurs using the heat level and print speed specified in the *Setup > Printing* menu.



**Notice!**

**The printout occurs without taking the label gaps into consideration. This is why endless media are most suitable for this purpose.**

- ▶ Insert printable medium (labels, endless paper) which extends across the entire printing width.
- ▶ If the printout is to occur using thermal transfer printing, insert transfer ribbon with the maximum width.
- ▶ Start menu.
- ▶ Select *Test > Wi-Fi status*.

The printout can be canceled with  .

Wi-Fi status			
Tue Feb 13 12:47:29 2018			
Brady i5100-300			
Firmware V5.14 (Feb 09, 2018) - #164162032326			
Channel	Name/BSS ID	Signal level	Security
1	default 00:24:b2:36:98:60	●●●●	WPA2-PSK
1	brady-dev 00:24:b2:36:98:61	●●●●	WPA2-PSK
1	brady-guest 00:24:b2:36:98:62	●●●●	WPA2-PSK
11	default 00:24:b2:36:98:60	●○○○	WPA2-PSK
11	brady-dev 00:24:b2:36:98:61	●○○○	WPA2-PSK
11	brady-guest 00:24:b2:36:98:62	○○○○	WPA2-PSK

Figure 18 Wi-Fi status

The parameters have the following meaning :

Column	Meaning
Channel	Channel; frequency range of the Access Point
Name/BSS ID	Name of the wireless LAN MAC address of the Access Points
Signal level	Scale of the Wi-Fi signal strength
Security	Type of data encryption

Table 23 Parameters of the *WiFi status*

## 8 Diagnostic Functions

The  *Diagnostics* menu contains several functions for troubleshooting

### 8.1 Printhead

The function *Printhead* provides an overview of important status information concerning the printhead on the display of the printer.

- ▶ Start menu.
- ▶ Select *Diagnostics > Printhead*.
- ▶ Return with *Close*.

The following parameters are displayed:

Line	Meaning	Example
1	Serial number of the printhead	<b>Serial no.</b> 72-0109
2	Part number of the printhead	<b>Part no.</b> 5977444
3	Firmware revision of the printhead	<b>Firmware</b> 2.1.0
4	Temperature of the printhead	<b>Temperature</b> 26.1 °C
5	Resolution of the printhead	<b>Resolution</b> 12 DPMM (dots/millimeter)
6	Print width / Number of dots	<b>Width/no. of dots</b> 106mm/1248
7	Operative time/Number of printed labels with the current printhead	<b>Hours/no. of labels</b> 34h/2935
8	Previously printed paper lengths with thermal direct printing / thermal transfer printing	<b>Thermal/Transfer</b> 0.00m/214.26m
9	Previously printed paper length with heat level < 0	<b>Heat level &lt;0</b> 22.08m
10	Previously printed paper length with heat level 0 - 7	<b>Heat level 0-7</b> 192.18m
11	Previously printed paper length with heat level 8 - 14	<b>Heat level 8-14</b> 0.00m
12	Previously printed paper length with heat level > 14	<b>Heat level &gt;14</b> 0.00m
13	Resistance of the printhead	<b>Resistance</b> 1078Ω
14	Description of the printhead	<b>Description</b> 4"/300dpi/Kyocera

Table 24 *Printhead display*

## 8 Diagnostic Functions

### 8.2 ASCII Dump Mode

*ASCII Dump Mode* offers the option of checking incoming control sequences at an interface. The commands are printed out as text. In addition, a corresponding error message is printed out immediately after an error occurs.

The printout occurs using the heat level and print speed specified in the *Setup > Printing* menu.



**Notice!**

The printout occurs without taking the label gaps into consideration. This is why endless media are most suitable for this purpose.



**Notice!**

In case of questions about programming, keep a printout of your label file which was created in *ASCII Dump Mode* handy. The printout can be transmitted clearly via fax.

- ▶ Insert printable medium (labels, endless paper) which extends across the entire printing width.
- ▶ If the printout is to occur using thermal transfer printing, insert transfer ribbon with the maximum width.
- ▶ Start menu.
- ▶ Select *Diagnostics > ASCII Dump Mode*.
- ▶ Send print jobs.
- ▶ Select  to cancel the printout or switch to the *Ready* mode.

**Example:**

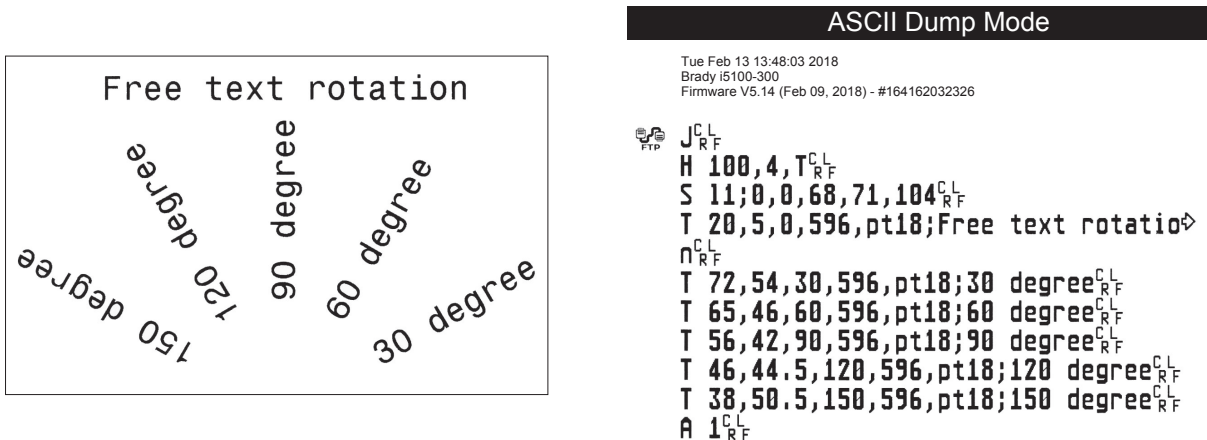

Figure 19 Example label printed normally (left) and in *ASCII dump mode* (right)

The control characters (ASCII-Code 00...31) are presented in stylized design.

- e.g. :  $L_F$  : Code 10 (0A) - line feed
- $C_R$  : Code 13 (0D) - carriage return



## 8 Diagnostic Functions

### 8.3 Label Profile

The *Label profile* function carries out a longer label advance. It saves the values measured by the label sensor here and then prints them out in a diagram.

The printout is used to check label detection in conjunction with the optical properties of the label medium.

The printout occurs using the heat level and print speed specified in the *Setup > Printing* menu.



**Notice!**

**The printout occurs without taking the label gaps into consideration. This is why endless media are most suitable for this purpose.**

- ▶ Select the label sensor to be tested in the *Setup > Labels* menu ▷ page 19.
- ▶ Load the label medium to be tested into the printer.
- ▶ Start menu.
- ▶ Select *Diagnostics > Label profile*.  
The printer performs a longer label advance. The label sensor measures the transparency/reflection capacity of the label material here. The message *Insert* appears in the display once the advance is complete.
- ▶ Insert printable medium (labels, endless paper) which extends across the entire printing width.
- ▶ If the printout is to occur using thermal transfer printing, insert transfer ribbon with the maximum width.
- ▶ Start the diagram printout with *Continue*.

The printout can be canceled with .

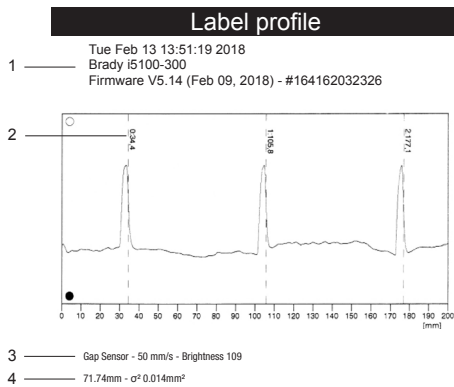

Figure 20 Label profile

No.	Information
1	Date and time of the printout Device type Version and creation date of the firmware Serial number of the PCB CPU Firmware version and serial number of the label sensor
2	Coordinate in the direction of paper flow at which the label start was detected
3	Print speed, method of label detection (Gap sensor / Bottom-reflect sensor) Brightness of the sensor LED during the measurement
4	Average value and variation of label distances

Table 25 Information in *Label profile*

## 8 Diagnostic Functions

### 8.4 Event Log

The label printer saves the following events in the *Event log*:

- Hardware fault
- Printhead replacement
- Firmware updates
- Changing the OEM name
- Resetting of the service counters

The printout occurs using the heat level and print speed specified in the *Setup > Printing* menu.



#### Notice!

**The printout occurs without taking the label gaps into consideration. This is why endless media are most suitable for this purpose.**

- ▶ Insert printable medium (labels, endless paper) which extends across the entire printing width.
- ▶ If the printout is to occur using thermal transfer printing, insert transfer ribbon with the maximum width.
- ▶ Start menu.
- ▶ Select *Diagnostics > Event log*.

Event log	
Tue Feb 13 14:15:58 2018	
Brady i5100-300	
Firmware V5.14 (Feb 09, 2018) - #164162032326	
Date	Description
19.10.17 07:45	New printhead, 300 dpi Ser. #72-01093
17.11.17 07:46	Firmware update -> V5.12 (0000)
30.11.17 13:38	Process 'printengine' terminated, Restart required
30.11.17 13:42	Process 'bdc' terminated, Restart required
08.12.17 14:01	Firmware update -> V5.13 (0000)
05.01.18 11:38	Cleaning interval -> 41242 + 1000000
13.02.18 10:25	Firmware update -> V5.14 (0000)



Figure 21 Event log

## 8 Diagnostic Functions

### 8.5 Save Data Stream

**\* Access only with external storage device!**

The function *Save data stream* allows to store data incoming via an interface as an .lbl file to an external storage device (SD card, USB memory module) installed on the printer.

- ▶ Insert SD card or USB memory module.
- ▶ Start menu.
- ▶ Select *Diagnostics > Save data stream*.
- ▶ Select the external storage device.
- ▶ Enter a file name.  
The predefined name is composed of the identifier "log", date, clock time and the suffix ".lbl", but may also be altered. Confirm the selection with .
- ▶ In the status line of the display the data saving is indicated by the symbol .
- ▶ Send print jobs. All data received by the printer are stored in the .lbl file.
- ▶ To complete the function select *Diagnostics > Save data stream* again and confirm with OK. The .lbl file will be stored in the root of the storage device.

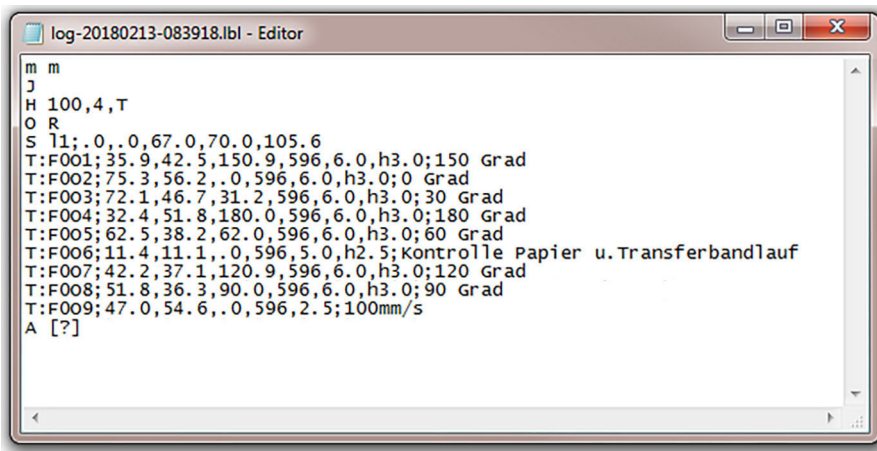

Figure 22 Saved data stream

## 8 Diagnostic Functions

### 8.6 Save Print Image

**\* Access only with external storage device!**

The function *Save print image* allows to store the last print image as a .png file to an external storage device (SD card, USB memory module) installed on the printer.

▶ Insert SD card or USB memory module.

▶ Start menu.

▶ Select *Diagnostics > Save print image*.

▶ Select the external storage device.

▶ Enter a file name.

The predefined name is composed of the identifier "img", date, clock time and the suffix ".png", but may also be altered.

▶ Confirm the selection with . The .png file will be stored in the root of the storage device.

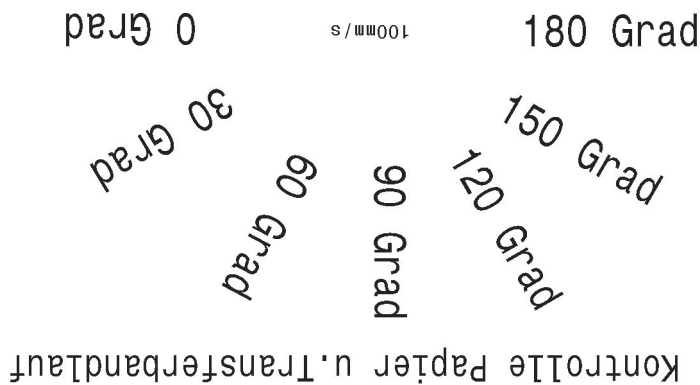

Figure 23 Saved print image

## 8 Diagnostic Functions

### 8.7 Save System Log

**\* Access only with external storage device!**

The function *Save system log* allows to store several system files packed to a .zip file to an external storage device (SD card, USB memory module) installed on the printer.

▶ Insert SD card or USB memory module.

▶ Start menu.

▶ Select *Diagnostics > Save system log*.

▶ Select the external storage device.

▶ Enter a file name.

The predefined name is composed of the identifier "sys", date, clock time and the suffix ".png", but may also be altered.

▶ Confirm the selection with  . The display shows the several steps of saving.

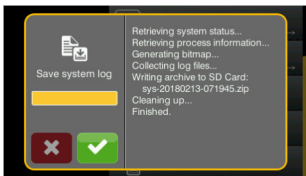



Figure 24 System log saving

▶ Confirm the completion of saving with  . The .zip file will be stored in the root of the storage device.

## 9 Extras

### 9.1 Firmware Update

\* **Access only with external storage device!**

- ▶ Copy the firmware file to the "misc" directory of the storage device. This can be done on a computer or via FTP on the printer.
- ▶ Insert the prepared storage device into the printer.
- ▶ Start menu.
- ▶ Select *Extras*.  
If the menu is protected via a PIN a prompt appears in the display. Enter the code number and confirm it.
- ▶ Select *Firmware update*.  
The display shows the selection of external storage devices and the firmware files stored on the devices.
- ▶ Select a file and confirm with  .  
The selected firmware file is copied. A progress indicator is displayed while the firmware is being copied. After completion the printer will be re-started.



**Notice!**

The firmware update also can be done via FTP printer management ▷ 11.4 on page 52.

### 9.2 Calibrate Label Sensor

With the *Calibrate label sensor* function the printers electronics can be adapted to the label sensor and the used liner material and transfer ribbon. This is necessary if sensor itself or CPU PCB has been changed.

- ▶ Start menu.
- ▶ Select *Extras > Calibrate label sensor*.  
The display shows *Step 1/4 Remove labels and ribbon*.
- ▶ Perform step 1 and select *Continue*.  
After a few seconds the display shows *Step 2/4 Insert liner*.
- ▶ Perform step 2 and select *Continue*.  
The display shows *Step 3/4 Remove liner, insert ribbon*.
- ▶ Perform step 3 and select *Continue*.  
The display shows *Step 4/4 Insert liner and ribbon*.
- ▶ Perform step 4 and select *Continue*.  
After a few seconds the message *Sensor successfully calibrated* appears.  
The display shows the characteristic values of the sensors e.g. *Brightness 2-4 / 22-139*.
- ▶ Select *Continue* to quit the function.

### 9.3 Save Settings

With the *Save settings* function the printer configuration can be saved to a storage device.

- ▶ Start menu.
- ▶ Select *Extras*.  
If the menu is protected via a PIN a prompt appears in the display. Enter the code number and confirm it.
- ▶ Select *Save settings*.
- ▶ Select the external storage device.
- ▶ Enter a file name.  
The predefined name is composed of the identifier "gui", date, clock time and the suffix ".xml", but may also be altered.
- ▶ Confirm the selection with  . The .xml file will be stored in the folder /misc of the storage device.

An error message appearing during the saving procedure may be caused by an unreadable medium (e.g. unknown medium, unformatted medium) ▷ 12.5.4 on page 55.

## 9 Extras

### 9.4 Load Settings

A printer configuration previously saved to a storage device can be loaded with the *Load settings* function.

- ▶ Start menu.
- ▶ Select *Extras*.  
If the menu is protected via a PIN a prompt appears in the display. Enter the code number and confirm it.
- ▶ Select *Load settings*.
- ▶ Select the desired file.
- ▶ Confirm the selection with . Loading of the configuration data starts. Do not remove the USB flash drive until the loading procedure is complete. The printer returns to the *Extras* menu.

If an error occurs during the loading procedure, an error message appears in the display. Restart the loading procedure in this case. If an error occurs again, the configuration parameters must be entered via the control panel.

### 9.5 Reset Settings

With the *Default settings* function all setup parameters excepting the passwords ▷ page 16 can be reset to the default values.

- ▶ Start menu.
- ▶ Select *Extras*.  
If the menu is protected via a PIN a prompt appears in the display. Enter the code number and confirm it.
- ▶ Select *Reset settings*.  
The display shows "Reset settings".
- ▶ Select *Continue*. The setup parameters will be reset and printer returns to the *Extras* menu.

### 9.6 Reset Passwords

The function *Reset passwords* allows to reset all passwords for the network services to the default values.

- ▶ Start menu.
- ▶ Select *Extras*.  
If the menu is protected via a PIN a prompt appears in the display. Enter the code number and confirm it.
- ▶ Select *Reset passwords*.  
The display shows "Reset passwords".
- ▶ Select *Continue*. The passwords will be reset and printer returns to the *Extras* menu.

Function	User name	Password
Web interface access	admin	admin
FTP printing	ftpprint	print
FTP access to storage devices	ftpcard	card
FTP firmware update	ftpadmin	admin
Web service	soap	soap

Table 26 Default passwords

## 9 Extras

### 9.7 Cleaning Interval

With the parameter *Cleaning interval* an interval for the printhead cleaning can be set in steps of 100 m media passage.

If the set length of the medium (label strip, transfer ribbon) has passed the printhead and an error occurs in the flow of the medium (e.g. label end, transfer ribbon end), the *Clean printhead!* message appears in the display.

The error message for the error which occurred is not displayed until the *Clean printhead!* message is acknowledged. As long as no errors occur in the medium flow, no messages are displayed and the print job is continued even if the cleaning interval has passed.

- ▶ Start menu.
- ▶ Select *Extras*.  
If the menu is protected via a PIN a prompt appears in the display. Enter the code number and confirm it.
- ▶ Select *Cleaning interval*.
- ▶ Select a new value and confirm the selection with  .

### 9.8 Legal Notices

The *Legal notices* function shows the licenses and software libraries of third party solutions used in the printer firmware.

- ▶ Start menu.
- ▶ Select *Extras*.  
If the menu is protected via a PIN a prompt appears in the display. Enter the code number and confirm it.
- ▶ Select *Legal notices*.  
The notices will be shown on the display
- ▶ Select *Close* to leave the notices.



## 10 Service Functions

### 10.1 Reset Service Counter

 **Access only with service key inserted!**

The printer has total and service counters.

- Total counter: The total counter contains the values for the entire service life of the printer up to now. The values of the total counter are displayed in the *Info* menu and in the *Status print*.
- Service counter: The service counter can be reset after more substantial maintenance or repair work with the service key inserted. Here, it provides information on the printing output since the last reset. The values of the service counter are displayed in the *Status print*.

The following data is recorded in both counters:

Data	Description
Operative time	Printer switch-on time
Number of labels	Number of labels printed
Transfer printing	Length of medium printed with transfer printing
Thermal printing	Length of medium printed with thermal direct printing

Table 27 Total and service counter data

- ▶ Insert service key into an USB master interface.
- ▶ Start menu.
- ▶ Select *Service > Reset service counter*.  
The display shows *Reset service counter*.
- ▶ Select *Continue*. The data recorded by the service counter is set to the value 0.

The status print can be used to check whether the values were reset.

### 10.2 Printhead Zero Position X

 **Access only with service key inserted!**

The purpose of the *Printhead zero pos. X* setting is to fundamentally align the printing image to the printhead perpendicular to the printing direction in order to compensate for printhead tolerances.

1. Determine the deviation of the actual from theoretical position of the printing image perpendicular to the printing direction.
2. Select menu *Service > Printhead zero pos. X*.
3. Choose a setting that counteracts deviation.

### 10.3 Printhead Zero Position Y

 **Access only with service key inserted!**

The purpose of the *Printhead zero pos. Y* setting is to fundamentally align the printing image to the printhead in the printing direction in order to compensate for printhead tolerances.

1. Determine the deviation of the actual from theoretical position of the printing image in the printing direction.
2. Select menu *Service > Printhead zero pos. Y*.
3. Choose a setting that counteracts deviation.

## 10 Service Functions

### 10.4 Printer Model



#### **Access only with service key inserted!**

With the *Printer model* function the firmware can be adapted to the device type.

- ▶ Start menu.
- ▶ Select *Service > Printer Model*.
- ▶ Select a model.

Following the *Info* function, all test prints and the web interface show the selected printer model.

## 11 FTP Printer Management

The File Transfer Protocol (FTP) allows to manage and transfer files on the network via the Ethernet interface or Wi-Fi adapter. An FTP program (FTP client) is required which supports the "binary" transfer mode to manage the printer. The printer functions as an FTP server.

FTP printer management is comprised of four functions:

- Direct printing via copying JScript or ZPL files.
- Management of the memory media installed in the label printer
- IFFS management
- Firmware update.

### 11.1 FTP Login

To establish an FTP connection, the client must be logged on to the server. The login type depends on the client. The following information must be specified in any case, however:

- IP address of the label printer
- User name and password

Access to the printer management functions depends on the user name:

Function	User name	Default password
FTP printing, loading PPP vouchers	ftpprint	print
FTP access to storage devices	ftpcard	card
FTP firmware update	ftpadmin	admin

Table 28 Default passwords



**Notice!**

▶ **The passwords can be changed in the "Setup" tab of the web interface ▶ page 29.**

After logging on the FTP server is accessible in a manner similar to a Windows folder.

### 11.2 FTP Printing

Label files in cab JScript format (▶ Programming Manual) or in ZPL format can be printed directly via FTP connection:

- ▶ Establish a FTP connection with the user name **ftpprint** and the defined password (Default: **print**)  
An empty folder of the FTP server will be shown.
- ▶ Copy a label file in JScript or ZPL format to the folder of the FTP server.  
Printing of the label file is started immediately. The corresponding file is deleted once the print job is complete.
- ▶ Close the FTP connection.

### 11.3 FTP Access to Storage Devices

FTP connection allows to manage data of a storage device:

- ▶ Establish a FTP connection with the user name **ftpcard** and the defined password (Default: **card**).  
The content of the storage device will be shown. The files are separated into several subfolders.
- ▶ Manage the files as necessary. When copying files to the folder, type-based sorting occurs automatically in the subfolders.
- ▶ Close the FTP connection.

## 11 FTP Printer Management

### 11.4 FTP Firmware Update

FTP allows to carry out a firmware update:

- ▶ Establish a FTP connection with the user name **ftpadmin** and the defined password (Default: **admin**).  
An empty folder of the FTP server will be shown.
- ▶ Copy a valid firmware file (e.g. 500\_6714.cfw) to the folder.  
The status of the saving procedure is shown by a progress indicator in the display. The printer resets automatically after the update is carried out successfully.
- ▶ Close the FTP connection.

Whether the firmware update was carried out successfully can be checked on the "Status" tab of the web interface.

## 12 Storage Devices

Label descriptions, graphics, fonts, and database information can be saved for the long-term on memory media.



### Notice!

- ▶ **Always create a backup copy of external devices in case of a malfunction.**

### 12.1 Suitable Storage Devices

#### External Devices

- USB flash drive at USB master interface.
- SD cards

#### Internal Device

- approx. 50 MB flash memory inside the printer (Internal Flash File System IFFS)

### 12.2 Installation

#### \* For external storage devices only!

- ▶ Slide SD card contact-side first into the matching slot until it latches. To unlatch SD card press it shortly into the slot and remove it.  
or
- ▶ Connect USB flash drive to an USB master interface.



### Attention!

#### Risk of data loss !

- ▶ **Do not remove the storage device while it is being accessed.**

### 12.3 Directory Structure

On storage devices connected to the printer, the following directory structure is automatically generated when uploading files:

Folder name	Contents
fonts	Font files
images	Graphic files
labels	Label description files
misc	Firmware, PPP, Setup and TMP files

Table 29 Directory structure

## 12 Storage Devices

### 12.4 Writing

The storage devices can be written to in several ways. The most functionally secure way is writing to the storage device via a data interface.



#### Attention!

The device selected as *Default storage* is written to by default. To write to another device specify the path name of the device in the file name (▷ [Programming Manual](#)).

#### Example:

With direct programming, the command sequence for saving a label (file XYZ) has the following form:



Ms LBL; XYZ	Command for saving the file <b>XYZ</b>
J	
H 100,0,T	
S l1;0,0,68,71,104	Contents of the file <b>XYZ</b>
T 10,10,0,3,pt15;memory card	
A 1[NOPRINT]	
Ms LBL	End of save command

- After transfer of the command sequence, the file XYZ is saved with the commands from J to A.
- Only one label is printed each time the file XYZ is called up.
- The [NOPRINT] parameter in command A suppresses the printing of a label when the file is saved.
- To print the label a variable number of times, use command A [?].

## 12.5 Storage Device Functions

### 12.5.1 Load Label

Labels whose descriptions are saved on the storage device can be printed using the *Load label* function.

- ▶ Start menu.
- ▶ Select *Storage > Load label*.  
The display shows the selection of external storage devices and the label files stored on the devices.
- ▶ Select a label and confirm with .  
If a label is selected which was saved with a fixed contents and fixed label quantity, the print job is started immediately.  
If additional input on the label description is required, the display requests to enter the variable data.  
For label descriptions with a variable label quantity, a prompt to enter the label quantity is displayed.
- ▶ Enter the label quantity/variable data and select  to start the print job.

## 12 Storage Devices

### 12.5.2 Print File List

The *Print file list* function creates a list of the files stored on the default storage device.



- ▶ Insert printable medium (labels, endless paper) which extends across the entire printing width.
- ▶ If the printout is to occur using thermal transfer printing, insert transfer ribbon with the maximum width.
- ▶ Start menu.
- ▶ Select *Storage > Print file list*  
The display shows the selection of storage devices
- ▶ Select a storage device and confirm with  .  
The directory of the storage device will be printed.

Contents of the printout:

- the name of the storage device
- information on the saved files
- the size of the available memory area

### 12.5.3 Copy Files

With the *Copy files* function files can be copied from one to another storage devices.

- ▶ Insert the storage devices.
- ▶ Start menu.
- ▶ Select *Storage > Copy files*.  
Under the headline *Source* the selection of storage devices will be shown.
- ▶ Select source device.
- ▶ Select a folder.
- ▶ Select files. One single file or all files (\*.\*) of the folder can be selected.
- ▶ Confirm the selection with  .  
Under the headline *Destination* the selection of storage devices will be shown again.
- ▶ Select destination device and folder.
- ▶ Confirm the selection with  .  
The files are copied. The display shows the message "*Copied ... file(s) to [Destination]*"
- ▶ Select *Continue* to return to the *Storage* menu.

### 12.5.4 Format Storage

The *Format* function can be used to delete all data from a storage device. This reformats the storage device. So you can also use the *Format* function if the *Unknown card* error message appears when using the device.

- ▶ Insert storage device
- ▶ Start menu.
- ▶ Select *Storage > Format storage*.  
If the function is protected via a PIN a prompt appears in the display. Enter the code number and confirm with *OK*.  
The display shows the selection of storage devices.
- ▶ Select a storage device and confirm the selection with  .  
The display shows the message *All data on the selected device will be lost*.
- ▶ Select *Continue*. The storage device will be formatted.  
Do not remove the device from the printer during the deleting procedure.  
The printer returns to the *Storage* menu.

## 12 Storage Devices

### 12.5.5 Default Storage

With the parameter *Default storage* Definition the storage device can be defined, which can be operated via interfaces and FTP printer management.

At functions started from the printer display all storage devices are accessible, but the default storage will be offered first.

- ▶ Start menu.
- ▶ Select *Storage > Default storage*.  
The display shows the selection of storage devices.
- ▶ Select a storage device and confirm the selection with  .



## 13 Remote Access via VNC

VNC is a software that allows remote control of a printer's operation control panel (server) via a computer (client) through input devices like keyboard and mouse.

VNC is not platform dependent and enables the use of a Windows computer as well as a mobile Android or iOS system as an external remote control. The prerequisite for this is the installation of a VNC client on the system used.

### Preparing the Computer

- ▶ Install the VNC client on the computer.

### Preparing the Printer

- ▶ Activate the VNC server under *Setup > Interfaces > Network services > VNC server*.
- ▶ Enter password *vnc* under *Security > Password VNC*.

For Wireless Access:

- ▶ Activate Wi-Fi under *Setup > Interfaces > Wi-Fi > Wi-Fi*.
- ▶ Find out the Wi-Fi-IP-Address under *Info*.

For Ethernet Access:

- ▶ Find out the Ethernet-IP-Address under *Info*.

### Establishing a Connection

- ▶ Start the VNC client on the computer.
- ▶ Enter the IP address and password *vnc* in the configuration of the VNC client.
- ▶ Activate the connection.  
The menu of the printer will be visible and usable via mouse click, keyboard or touch-pad just like on the printer itself.

## 14 External Keyboard

An external keyboard or a compatible input device (e.g. barcode scanner) can be connected directly to the printer. Using an external keyboard facilitates the entry of variable data while processing print jobs and printing from storage devices. Input prompts and the data received from the keyboard are shown in the display.

### 14.1 Connecting External Keyboard

Any HID compatible USB keyboard can be connected to the printer.

- ▶ Insert connection cable of the keyboard into a USB master interface of the printer.

### 14.2 Keyboard Assignment

- ▶ If necessary set the parameter *Setup > Region > Keyboard* matching to the used keyboard.



**Notice!**

- ▶ If the parameter *Keyboard* is set to *Automatic*, the keyboard assignment will be defined by the setting of the parameter *Country*.

The following *Country* settings have special keyboard assignment :

Country	Keyboard
China	USA
South Africa	USA
Taiwan	USA
Mexico	Latin America
Egypt	Arabic

Table 30 Special assignments *Country - Keyboard*

For the following *Keyboard* settings can be switched between two assignments by pressing the CTRL key and the SHIFT key:

Keyboard	First assignment	Second assignment
Bulgaria	Latin	Cyrillic
Greece	Latin	Greek
Iran	Latin	Persian
Macedonia	Latin	Cyrillic
Russia	Latin	Cyrillic
Thailand	Latin	Thai
Arabic	Latin	Arabic

Table 31 *Keyboard* settings with double assignment

## 14 External Keyboard

### 14.3 Special Key Functions

**General :**





[F1]	Executes the <i>Load label</i> storage device function.
[F2]	Prints an additional label from the last print job. Corresponds to  .
[F3]	Repeats the last print job with renewed polling of the variable data and polling of the label quantity.
[F8]	Functions like  .
[Enter]	Starts menu
[Esc]	Functions like  .
[Space]	Functions like  .

Table 32 Special key functions: general

**In the menu and for entry of variable data:**

[Enter]	Confirms the input.
[Esc]	Cancels the input and returns.
[Shift][Entf]	Clears the input line.

Table 33 Special key functions: Menu and data input



**Attention!**

When using a scanner operated as keyboard emulation ensure that the same character set is set for both the scanner and the printer.

## 15 Index

<b>A</b>		<b>H</b>		<b>S</b>	
ASCII dump mode .....	41	Heat level.....	17	Save data stream .....	44
<b>B</b>		<b>I</b>		Save print image.....	45
Backfeed.....	18	IFFS.....	52, 54	Save settings .....	47
Backfeed position .....	18	Important information.....	5	Security tab.....	30
Baud rate .....	23	Interfaces.....	21	Service key.....	14
Bluetooth .....	11, 26	Interpreter.....	26	Setup tab .....	29
Brightness.....	26	IP .....	21, 22	Single print mode.....	18
<b>C</b>		<b>J</b>		Status print .....	34
Calibrate sensor .....	47	JScript.....	26	Status tab .....	28
Character set.....	26	<b>K</b>		Storage device functions .....	55
Cleaning interval.....	49	Keyboard .....	59	Storage devices	
Connecting to computer .....	6	Key functions .....	60	Directory structure .....	54
Control characters .....	41	<b>L</b>		Installation.....	54
Country.....	24	Label profile .....	42	Print labels .....	55
Cut offset .....	20	Labels.....	19	Writing.....	55
Cutting .....	20	Label sensor .....	19	<b>T</b>	
<b>D</b>		Legal notices .....	49	Tearing-off.....	20
Date .....	25	Load label.....	55	Tear-off mode .....	20
Daylight saving .....	25	Load settings .....	48	Tear-off position .....	20
Device list .....	36	<b>M</b>		Test grid .....	37
Devices tab.....	31	Menu.....	12	Time.....	25
DHCP .....	21, 22	<b>N</b>		Time powersave .....	26
<b>E</b>		<b>P</b>		Transfer print .....	19
Errors.....	24	Network services .....	23	<b>U</b>	
Ethernet.....	21	<b>P</b>		USB memory .....	54
Ethernet interface .....	6, 7	Passwords .....	52	USB slave interface .....	6
Event log.....	43	Peeling-off .....	20	<b>V</b>	
Extrapolate labels .....	19	Printing .....	17	VNC.....	58
<b>F</b>		Printing intensity .....	17	<b>W</b>	
Firmware update		Print offset .....	17	Web interface .....	27
from storage device .....	47	Print services.....	6	Wi-Fi .....	22
via FTP.....	53	Print speed .....	17	Wi-Fi status.....	38, 39
Firmware version.....	28	Protocol .....	23	Windows printer setting .....	6
Font list.....	35	<b>R</b>		<b>Z</b>	
Font tab .....	32	Raw-IP.....	6	ZPL.....	26
Format storage .....	56	Region .....	24		
FTP.....	52	Reset service counter.....	50		
FTP login .....	52	Reset settings.....	48		
FTP server.....	52	Ribbon .....	19		
<b>G</b>		RS-232 .....	23, 26		
Gateway .....	21, 22				



## Locations

### Brady Worldwide, Inc

6555 West Good Hope Road  
P.O. Box 2131  
Milwaukee, WI 53201-2131  
[www.bradycorp.com](http://www.bradycorp.com)  
Tel: 800- 537-8791

### Brady EMEA

Lindestraat 20  
9240 Zele  
Belgium  
[www.bradycorp.com/global](http://www.bradycorp.com/global)  
Tel: +32 (0) 52 45 78 11

### Brady Corporation Asia

1 Kaki Bukit Crescent  
Singapore 416236  
[www.bradycorp.com/global](http://www.bradycorp.com/global)  
Tel: 65-6477-7261

### Brady Worldwide

Australia.....	612-8717-6300
Brazil.....	55-11-3686-4720
Canada.....	1-800-263-6179
China (Beijing).....	86-10-6788-7799
China (Shanghai).....	86-21-6886-3666
China (Wuxi).....	86-510-528-2222
Hong Kong.....	852-2359-3149
Japan.....	81-45-461-3600
Korea.....	82-31-451-6600
Latin America.....	1-414-540-5560
Malaysia.....	60-4-646-2700
Mexico.....	525-399-6963
New Zealand.....	61-2-8717-2200
Philippines.....	63-2-658-2077
Singapore.....	65-6477-7261
Taiwan.....	886-3-327-7788
Thailand.....	66-2-793-9200